

GIO54_REV1.4

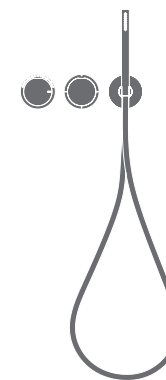

DESIGN
NATALINO MALASORTI





GIO54/GIOTTO
AISI 316/L STAINLESS STEEL

Gruppo miscelatore termostatico a parete per vasca/doccia con Acqua Stop System, deviatore 2/3 vie e doccetta





Wall mounted thermostatic mixer set for bathtub/shower with Acqua Stop System, 2/3 way diverter and hand shower



PRODOTTI CORRELATI / RELATED PRODUCTS
FRE74 - FRE202 - MIL91

-  Possibilità di installazione a 180°
Installation possibility at 180°
-  Prodotto che necessita di parte incasso
Product that needs built-in part
-  Staffa ausiliaria per cartongesso / fibrogesso
Auxiliary bracket for plasterboard / fiber-board structures

MANUTENZIONE / MAINTENANCE

NON UTILIZZARE DO NOT USE		acido clorico e muriatico <i>cloric and muriatic acid</i>
		acido fluoridrico <i>hydrofluoric acid</i>
		ipoclorito di sodio <i>chlorine bleach</i>
UTILIZZARE TO USE		sapone a PH neutro <i>neutral PH soap</i>

Questi disegni sono proprietà di CEADDESIGN SRL s.u. pertanto non potranno essere utilizzati e/o comunicati a terzi, anche in forma parziale, senza preventiva autorizzazione. CEADDESIGN SRL s.u. si riserva il diritto di apportare modifiche ai disegni al fine di migliorare il prodotto.

CEADDESIGN SRL s.u. has the property rights on these drawings, therefore they cannot be used and/or transferred to third party, even in partial form, without any prior authorization. Furthermore CEADDESIGN SRL s.u. reserves the right to apply any change to these drawings in order to upgrade the product.

CEA

ceadesign.it

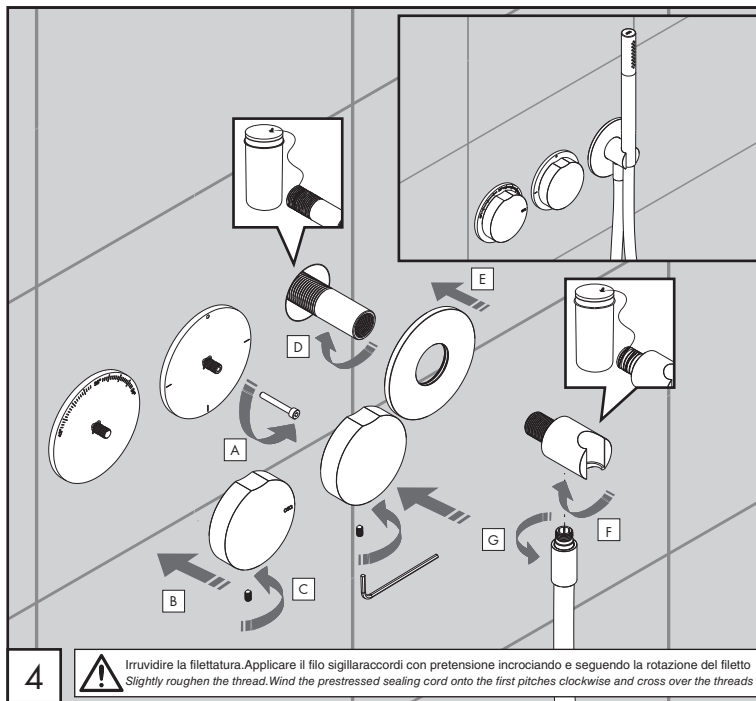
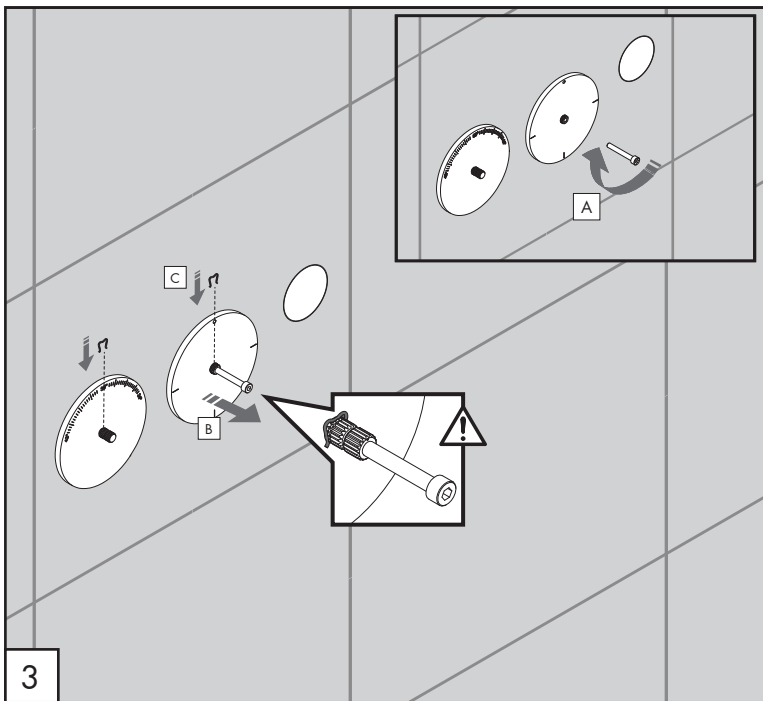
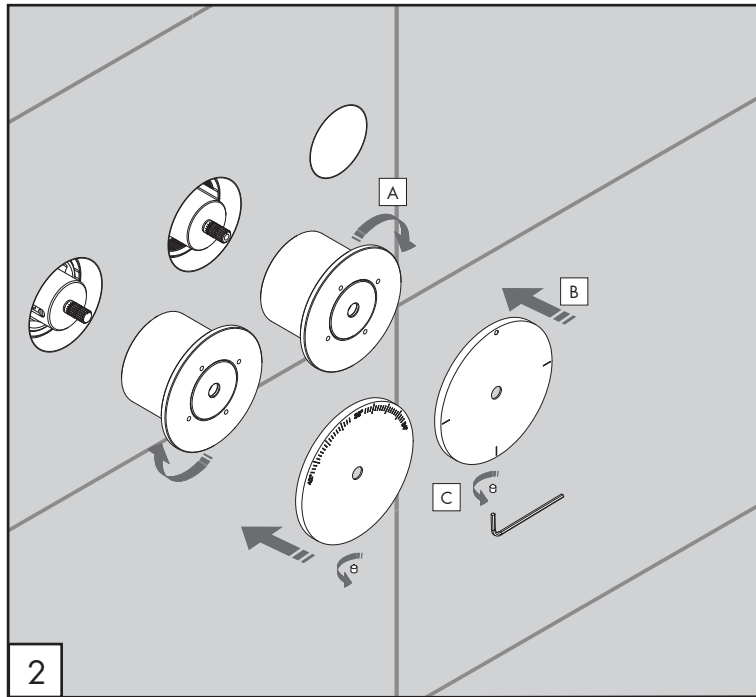
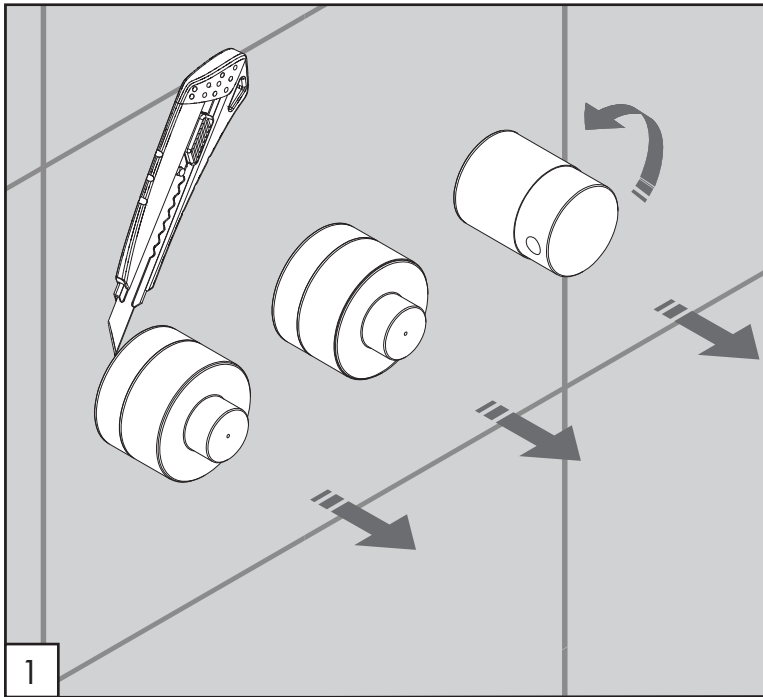

AVVERTENZE TECNICHE

Risciacquare bene le tubazioni prima del montaggio ed evitare sbalzi di pressione fra i raccordi d'acqua fredda e d'acqua calda. In caso di pressioni statiche superiori a 5 bar si raccomanda l'installazione di un riduttore di pressione per evitare danni alla cartuccia.

TECHNICAL WARNINGS

The pipes have to be rinsed thoroughly before installation. Avoid pressure differences between hot and cold water supply. Use of a pressure reducer when static pressure is higher than 5 bar to avoid damage of the cartridge.

TECHNISCHE WARNUNG

Spülen Sie die Leitungen vor dem Einbau und verhindern Sie Wasserdruckwechsel zwischen kalt und warm Wasserverbindungen. Wenn Wasserdruck größer als 5 bar ist, bitte reduzieren Sie den Systemdruck, um Beschädigung der Kartusche zu verhindern.

ADVERTENCIA TÉCNICA

Los tubos tienen que ser enjuagados a fondo antes de la instalación. Evitar grandes diferencias de presión entre las conexiones de agua caliente y fría. En caso de presión estática mayor de 5 bar, se recomienda el uso de un adaptador de presión para evitar daños en el cartucho.

ADVERTISSEMENTS TECHNIQUES

Rincer les tuyaux avant l'installation. Éviter des grandes différences de pression entre l'eau froide et chaude. En cas de pressions statique de plus de 5 bar, nous vous recommandons d'installer un réducteur de pression pour éviter des dommages à la cartouche.

PORTATE / FLOW RATE

BAR	uscita 1 / outlet 1		uscita 3 / outlet 3	
	l/min	gpm	l/min	gpm
1	11,2	2.9	11,7	3.1
2	15,8	4.2	16,6	4.4
3*	19,2	5.1	20,2	5.3
4	22,0	5.8	23,3	6.2
5	24,9	6.6	26,1	6.9

BAR	uscita 2 doccia / hand shower outlet 2			
	acciaio inox / stainless steel		gomma siliconica / silicone rubber	
	l/min	gpm	l/min	gpm
1	8,1	2.1	6,8	1.8
2	12,3	3.3	10,1	2.7
3*	15,4	4.1	11,9	3.1
4	17,8	4.7	13,2	3.5
5	19,9	5.3	14,5	3.8

* Pressione consigliata
Recommended pressure

max. 65 °C
max. 149 °F

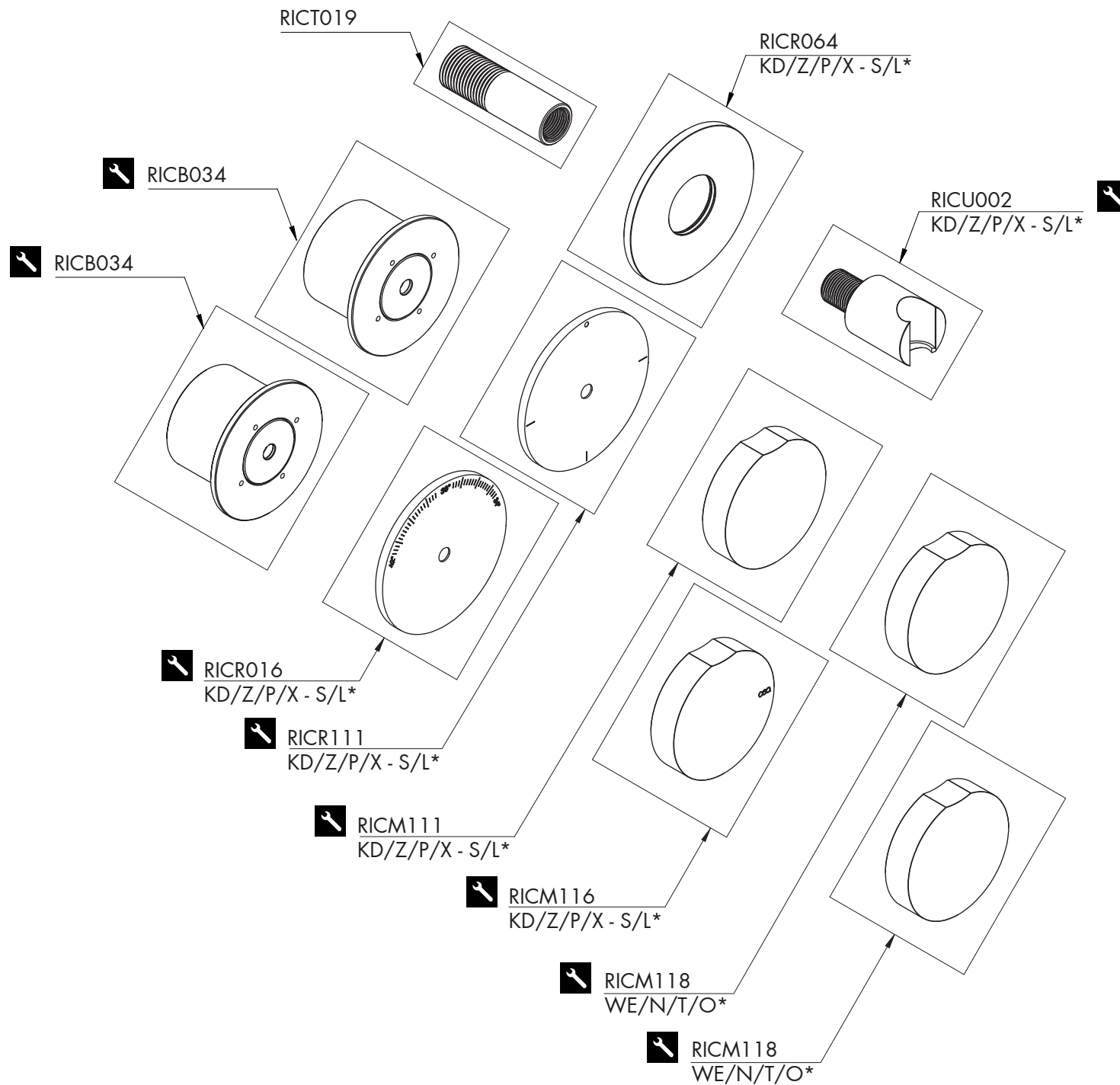

RICAMBI / SPARE PARTS

RICB034	Carter / Carter
RICM111	Maniglia / Handle
RICM116	Maniglia / Handle
RICM118	Maniglia / Handle
RICR016	Rosetta / Rosette
RICR064	Rosetta / Rosette
RICR111	Rosetta / Rosette
RICT019	Raccordo / Fitting
RICU002	Supporto doccetta / Hand shower holder

! Conservare gli strumenti inclusi nel prodotto e utilizzarli per l'installazione perchè riutilizzabili per i ricambi.
Please, keep the tools included in the item pack and employed for its installation, to re-used them for the spare parts.
Die Werkzeuge, die Sie für die Installation des Produktes benutzt haben, bitte aufbewahren, da sie auch für die Installation der Ersatzteile benutzt werden können.
No tirar las herramientas incluidas en el producto y usadas durante la instalación puesto que se pueden reutilizar para los recambios.
Veuillez conserver les outils inclus dans la boîte du produit et employés pour son installation, parce que réutilisables pour les pièces de rechange.

LEGENDA / LEGEND

ICONE / ICONS

Utensile incluso nel ricambio
Tool included in spare part

FINITURE / FINISHES

*S finitura satinata / satin finish
L finitura lucidata / polished finish

FINITURE SPECIALI / SPECIAL FINISHES

KD black diamond
Z bronzo / bronze
P rame / copper
X light gold

ESSENZE LEGNO / WOOD ESSENCES

*WE wengè / wenge
N noce americano / american walnut
T teak birmano / burma teak
O rovere / oak

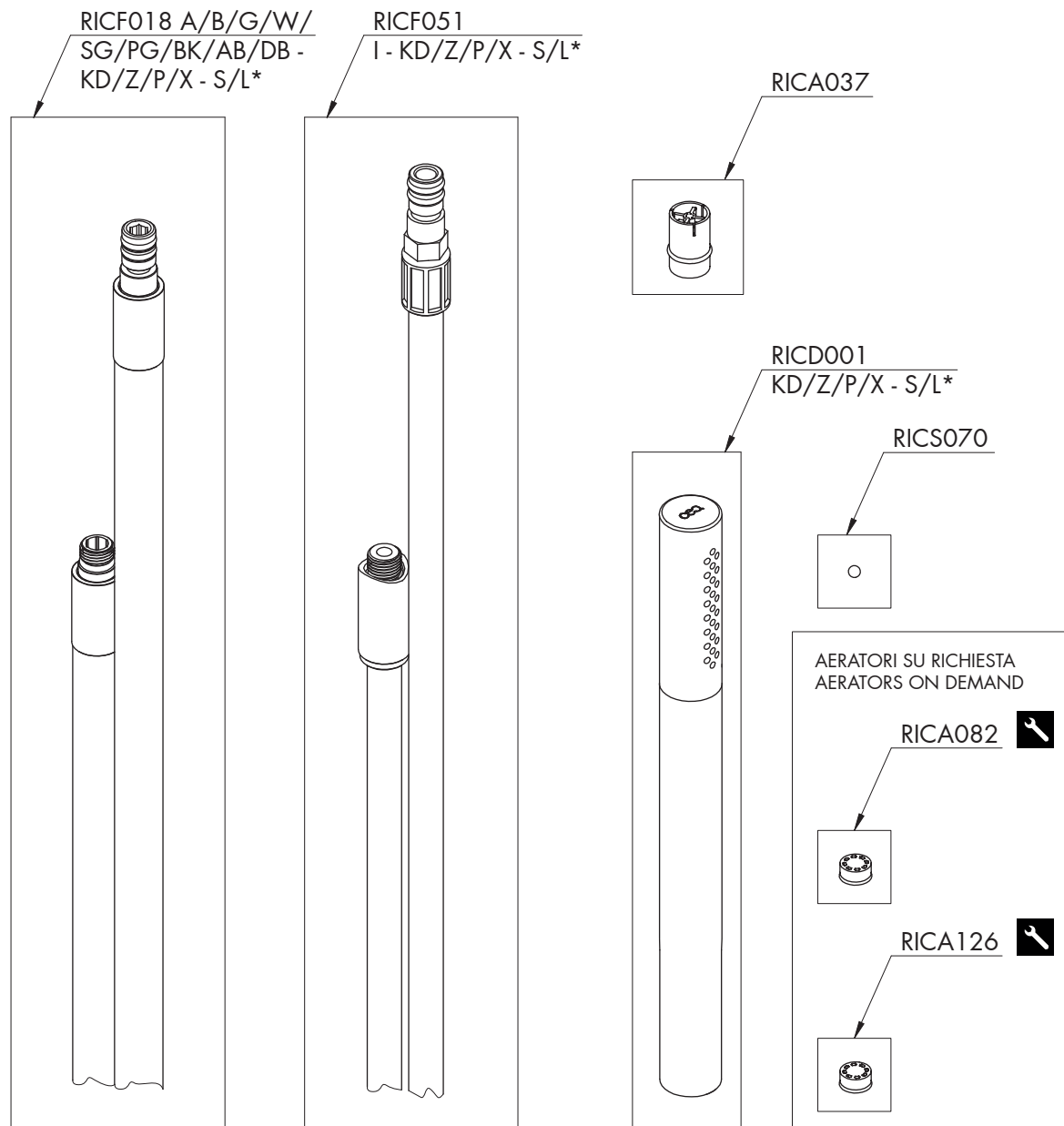

RICAMBI / SPARE PARTS

RICA037	Valvola di non ritorno / <i>Check valve</i>
RICD001	Doccetta / <i>Hand shower</i>
RICF018	Flessibile / <i>Hose</i>
RICF051	Flessibile / <i>Hose</i>
RICS070	Sfera in acciaio inox Ø 3,5 mm <i>Stainless steel ball Ø 3,5 mm</i>

AERATORI SU RICHIESTA / AERATORS ON DEMAND

RICA082	Riduttore di portata / <i>Flow regulator</i> 7,3 l/min / <i>1.9 gpm</i>
RICA126	Riduttore di portata / <i>Flow regulator</i> 6,8 l/min / <i>1.8 gpm</i>

LEGENDA / LEGEND

ICONE / ICONS

 Utensile incluso nel ricambio
Tool included in spare part

FINITURE / FINISHES

*S finitura satinata / *satin finish*
L finitura lucidata / *polished finish*

FINITURE SPECIALI / SPECIAL FINISHES

KD black diamond
Z bronzo / *bronze*
P rame / *copper*
X light gold

COLORI FLESSIBILE / HOSE COLOURS

A	verde acqua / <i>aqua green</i>	RAL 6027
B	blu cobalto / <i>cobalt blue</i>	RAL 5013
G	grigio antracite / <i>anthracite grey</i>	RAL 7043
W	bianco / <i>white</i>	RAL 9016
SG	grigio seta / <i>silk grey</i>	RAL 7044
PG	verde petrolio / <i>petroleum green</i>	RAL 5020
BK	nero / <i>black</i>	RAL 9004
AB	blu avio / <i>air force blue</i>	RAL 5014
DB	grigio quarzo / <i>quartz grey</i>	RAL 7006
I	acciaio inox / <i>stainless steel</i>	